



 Scala a chiocciola disponibile con forma tonda o quadra;
Gradini in legno di faggio;
Palo centrale in metallo o legno (optional);
Ringhiera con colonne in acciaio verniciato;
Corrimano in legno.

 Spiral staircase available with round or square shape;
Beech wood steps;
Central pole in metal or wood (optional);
Banister composed of painted steel columns;
Wood handrail.

 Escalier en colimaçon disponible ronde ou carrée ;
Marches en bois de hêtre ;
Poteau central en métal ou en bois (en option) ;
Rampe avec colonnes en acier vernissé;
Main courante en bois.

 Spindeltreppe mit runder oder quadratischer Form erhältlich;
Stufen aus Buchenholz;
Zentralstange aus Metall oder Holz (optional);
Geländer mit lackierten Stahlsäulen;
Handlauf aus Holz.

 Escalera de caracol disponible con forma redonda o cuadrada;
Escalones de madera de haya;
Poste central en metal o madera (opcional);
Barandilla con columnas de acero pintado;
Pasamano fabricado en madera.

Dettagli tecnici Technical details - Détails techniques Technische Details - Ficha técnica

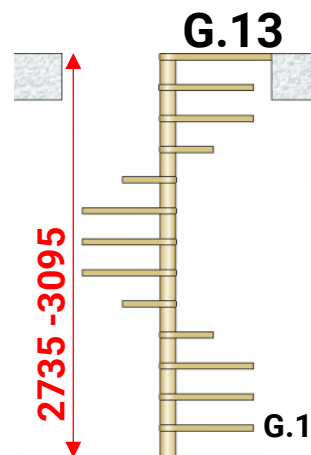
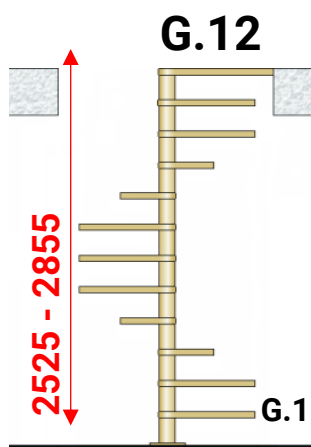
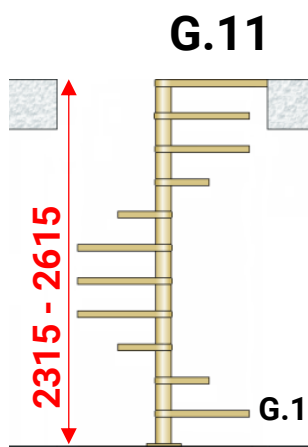

IMBALLO
Dim. 115x97x74 cm
Peso: circa 190/250 kg.

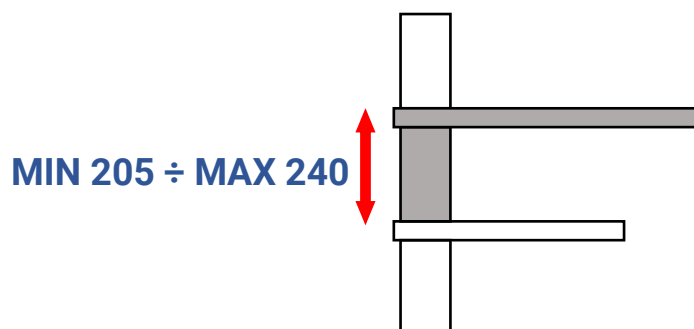
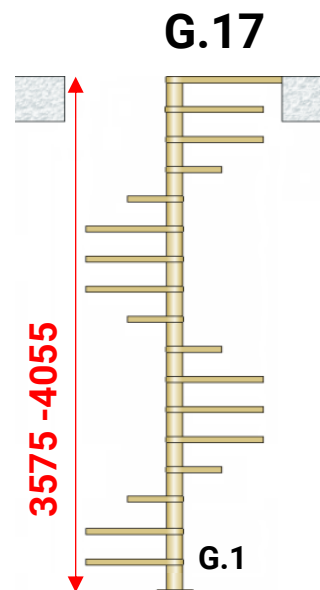
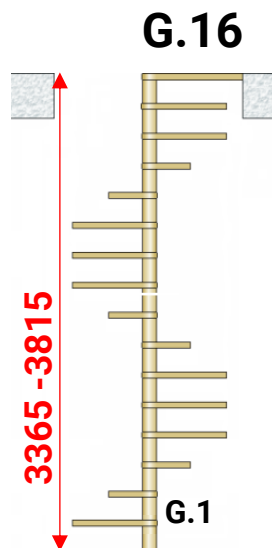
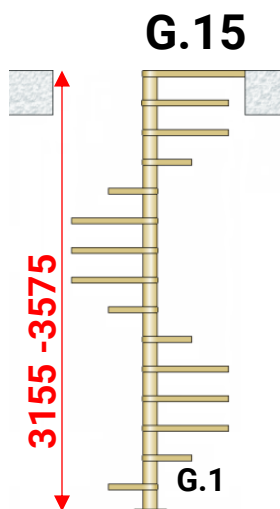
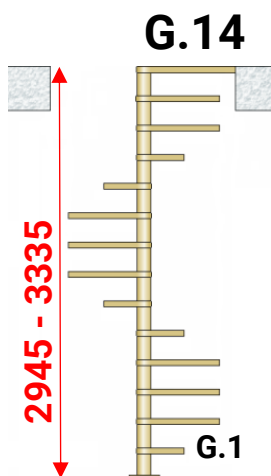

Dettagli tecnici

Technical details - Détails techniques

Technische Details - Ficha técnica

L	C1	C2	C3	P.U.	P.M.
Ø1100	622	729	601	430	144,9
Ø1200	675	787	649	480	157,9
Ø1300	722	846	696	530	170,8
Ø1400	773	904	743	580	165,7
Ø1500	823	962	791	630	177,4
Ø1600	873	1021	838	680	189,1

FORO, WELL, TRÊMIE, LOCH, HUECO

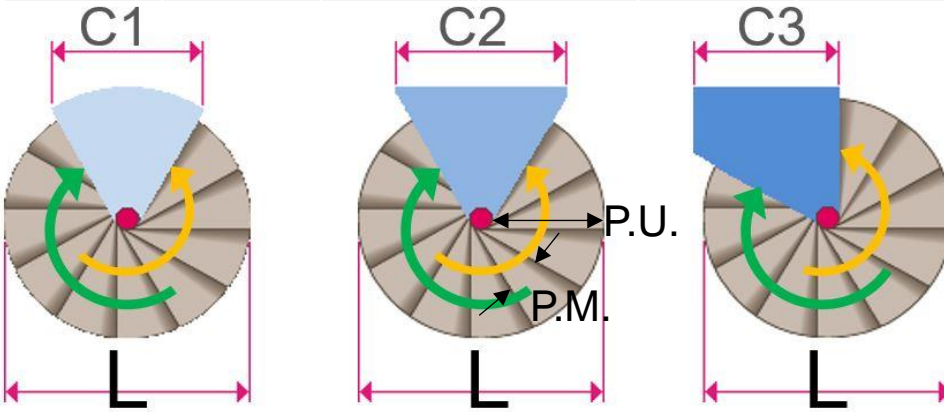
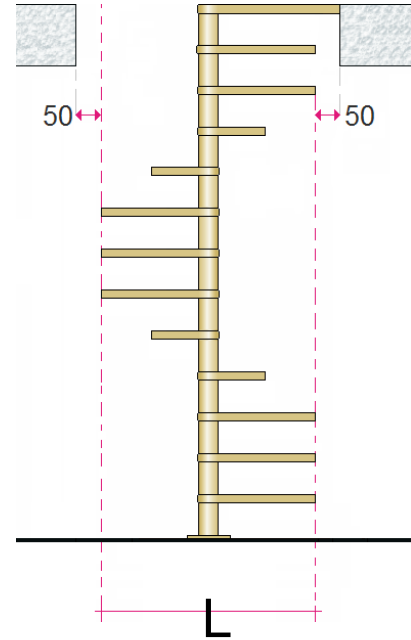

FISSAGGIO ARRIVO SBARCO, FIXING OF THE ARRIVAL LANDING, FIXATION DU PALIER D'ARRIVÉE, BEFESTIGUNG DES ANKUNFTSPODESTS

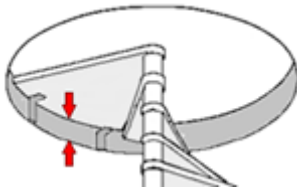

MIN 210

LEGNO, WOOD, BOIS, HOLZ, MADERA

APERTURA GRADINI, TREADS OPENING, OUVERTURE DES MARCHES, ÖFFNUNG DER STUFEN, APERTURA DE LOS ESCALONES



Faggio
Beech
Hêtre
Buche
Haya

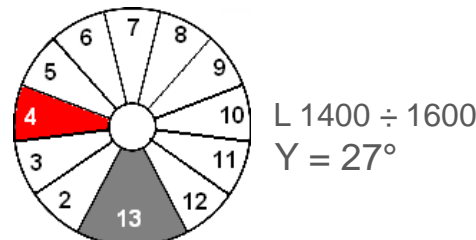
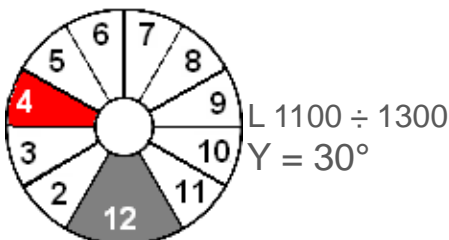

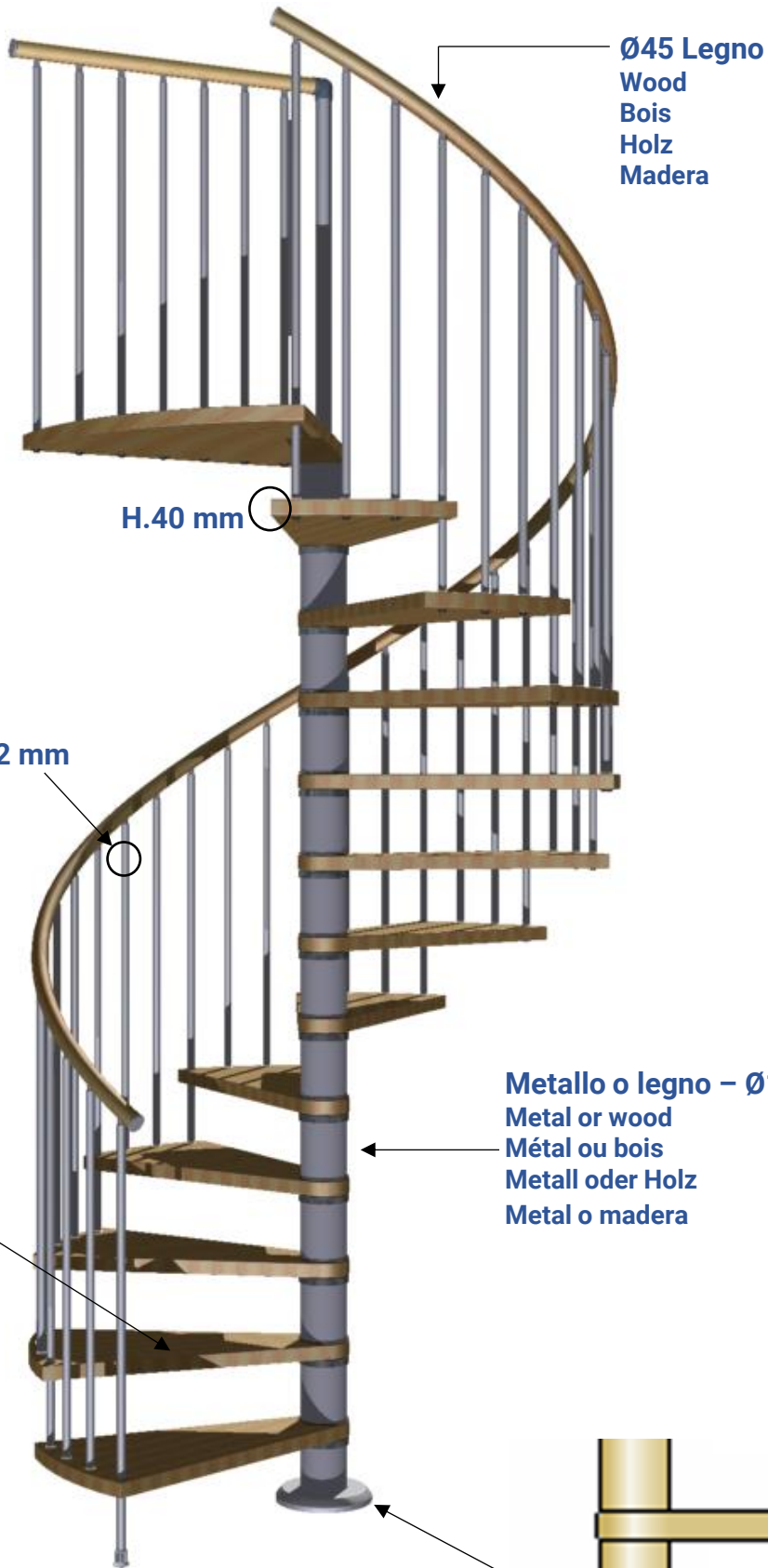

Ø45 Legno
Wood
Bois
Holz
Madera

H.40 mm

Ø 22 mm

 200 Kg/m²

Metallo o legno – Ø127
Metal or wood
Métal ou bois
Metall oder Holz
Metal o madera

60 mm

Dettagli tecnici Technical details - Détails techniques Technische Details - Ficha técnica

L	C1	C2	C3	P.U.	P.M.
Ø1120	622	729	601	430	144,9
Ø1220	675	787	649	480	157,9
Ø1320	722	846	696	530	170,8
Ø1420	773	904	743	580	165,7
Ø1520	823	962	791	630	177,4
Ø1620	873	1021	838	680	189,1

FORO, WELL, TRÊMIE, LOCH, HUECO

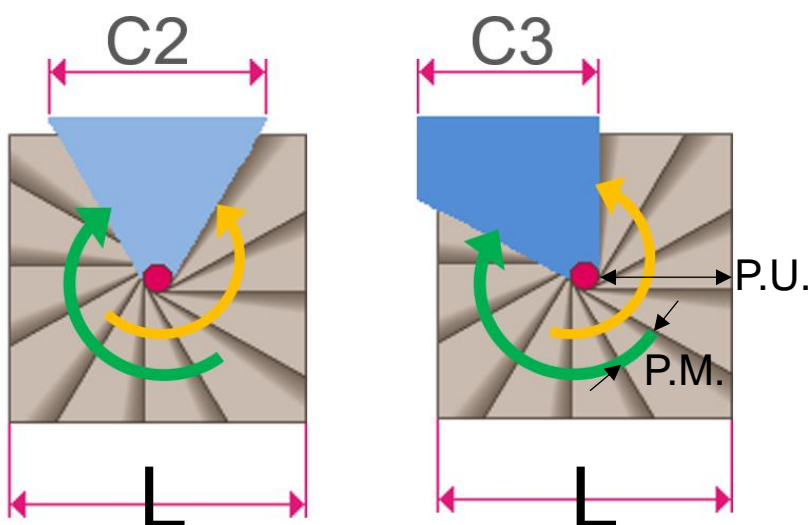
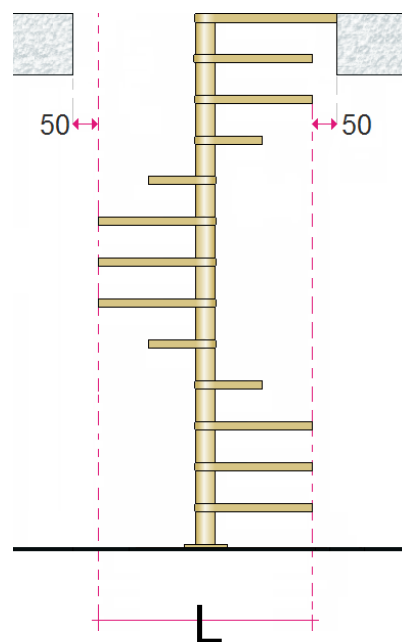

FISSAGGIO ARRIVO SBARCO, FIXING OF THE ARRIVAL LANDING, FIXATION DU PALIER D'ARRIVÉE, BEFESTIGUNG DES ANKUNFTSPODESTS

LEGNO, WOOD, BOIS, HOLZ, MADERA

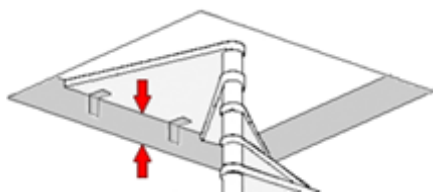

MIN 210



Faggio
Beech
Hêtre
Buche
Haya

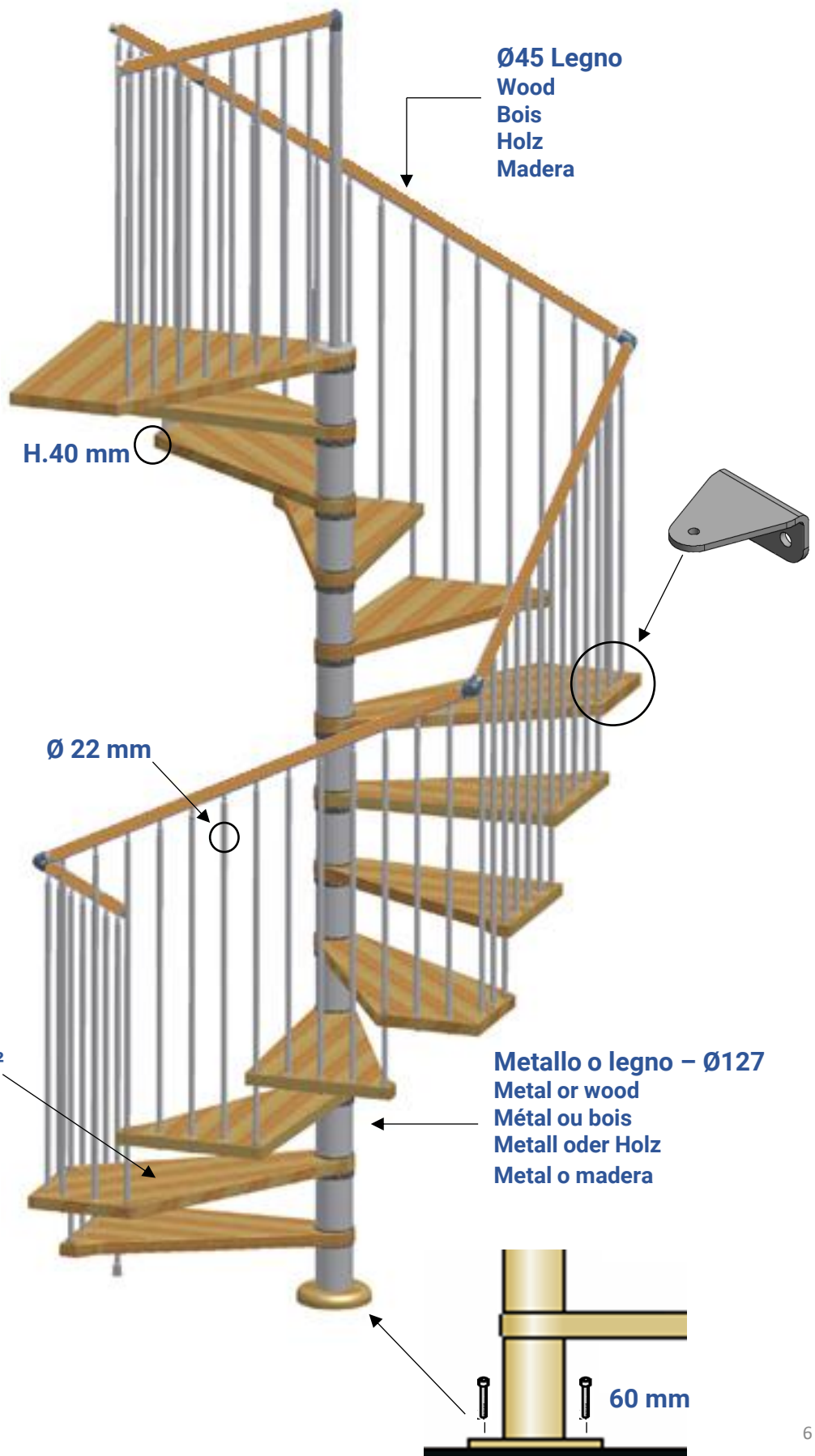

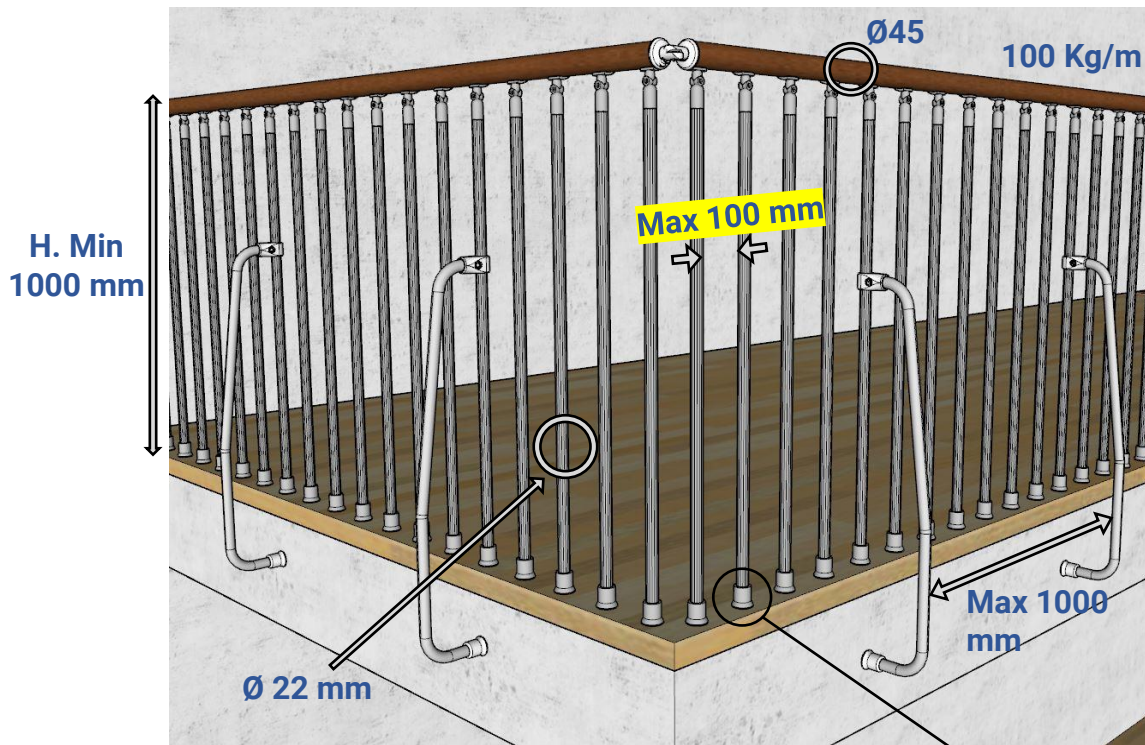

60 mm

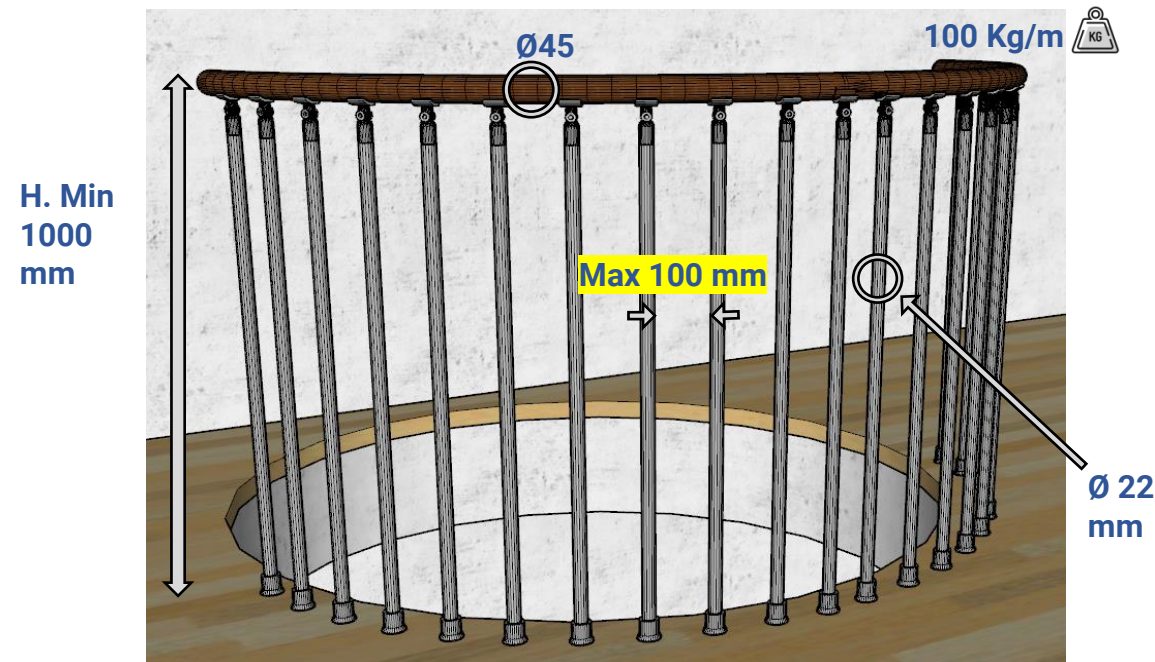

Sbarco su misura

Landing on measure - Palier sur mesure
Podest nach Maß - Desembarque personalizado

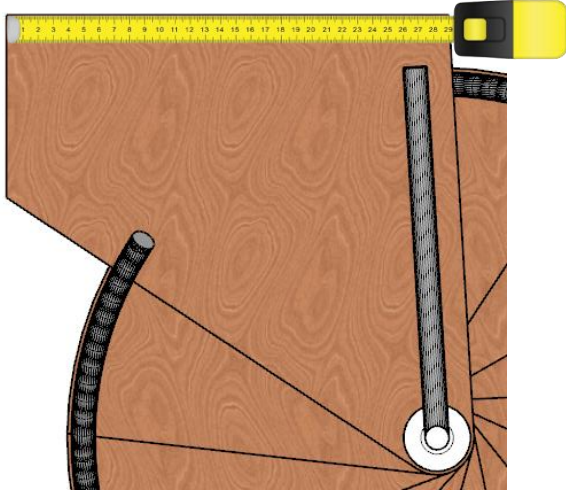

Corrimano a muro

Wall handrail - Main courante au mur
Wand-Handlauf, pasamanos de pared



Scala sovrapposta

Overlapping staircase - Escalier superposé,
überlagerte Treppe - Escalera superpuesta

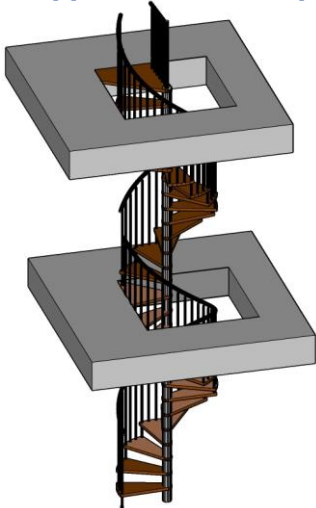

Piastra incollata

Glued Plate - Plaque collée - Geklebte Platte,
Placa encolada

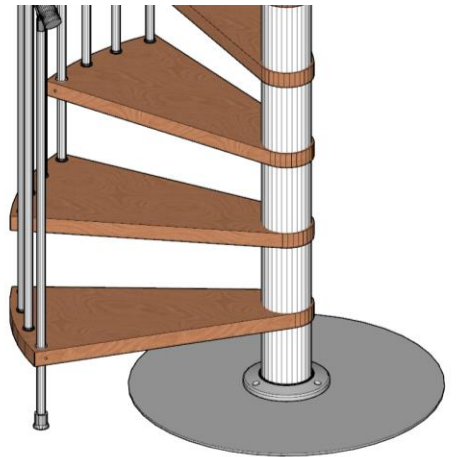

Pianerottolo tondo

Round landing - Palier ronde
Runde Podest - Desembarco redondo

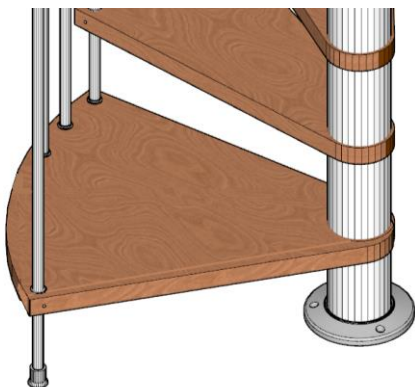

Pianerottolo quadro

Square landing - Palier carré
Viereckiges Podest - Desembarco cuadrado

